

Studio Standard Series

# L-3

## SOLID STATE STEREO INTEGRATED AMPLIFIER

The L-3 was so designed as to offer diversified facilities, while retaining the slim, precision-look common to our prestigious line of "Laboratory Reference Series" and "Laboratory Standard Series".



**LUX CORPORATION, JAPAN**

# CONTENTS

- SWITCHES & TERMINALS ..... 2-5
- CONNECTION & OPERATION OF  
RECORD PLAYER & TUNER ..... 6-9
- CONNECTION & OPERATION OF  
TAPE DECK ..... 10-11
- OPERATION OF CONTROLS ..... 12-13
- BEFORE CONSULTING A  
SERVICE SHOP ..... 14
- STANDARD CURVES ..... 15
- SPECIFICATIONS ..... 16

## **WARNING:**

TO PREVENT FIRE OR SHOCK HAZARD  
DO NOT EXPOSE THIS APPLIANCE TO  
RAIN OR MOISTURE.

## Thank you for purchasing the L-3.

The L-3 is an integrated amplifier, producing power output of 42 watts both channels driven into 8 ohms load. Though built with extremely sophisticated engineering, its concept is quite simple: to produce an amplifier with performance comparable to that available in the finest players, tuners and speaker systems.

The L-3 represents the finest standards of design and craftsmanship, but the proof is in the handling — and in the listening. As you proceed to connect the amplifier, may we suggest that you read all the instructions carefully before turning the unit on? A few moments invested not can eliminated doubts or delays later. If you have any question, please do not hesitate to consult your dealer!



# SWITCHES & TERMINALS

## 1. Input Selector Buttons

These 3 buttons permit proper selection of desired program sources (phono, tuner, aux). As so called "see-saw" switch is employed, when one of these buttons is depressed, the others protrude automatically. When 2 or 3 buttons are depressed compulsorily at the same time, only the right-hand one is operative.

## 2. Volume Control

This knob controls volume. Clockwise turn boosts volume, while counter-clockwise rotation decreases and finally cuts off volume.

## 3. Balance Control

The volume balance between right and left channels can be adjusted by this control. Turn it in the clockwise direction from the center click position, and the volume level of the left channel is reduced. Conversely, a counter-clockwise turn causes decrease of volume at the right channel. When the volume of both channels is balanced, monaural playback sound comes from the center of right and left speakers. Usually this point is obtained at the center click point.

## 4. AC Power Switch

Press alternately for ON or OFF.

## 5. Pilot Lamp

Press in the AC Power Switch (4) and this lamp lights up, which shows that the electric current is on.

## 6. Mode Selector Button

Use this button to select reproduction modes such as Stereophonic or Monaural. When the button is depressed reproduction is made in monaural mode. For further details, refer to Mode Selection.

## 7. Tape Monitor Button

When this button is depressed, playback is possible either from "tape-1" or "tape-2". The tape connector (27) is also functionable when the switch is set to the "ON" position (depressed). This is coupled to the Tape Selector Button, and for the tape monitoring, it is necessary to select the deck by the Tape

Selector.

In case of 3-head tape deck which has a separate playback head for playback, simultaneous playback monitoring is then possible while recording. In this case this amplifier receives the playback signals from the "monitor" terminal or tape connector while feeding the recording signals to REC. OUT and tape connector.

Caution: if this switch is kept unpressed in the "protruded" position, no playback is possible from tape recorder.

## 8. Tape Selector Button

This button is provided to select two tape decks connected. When the button is kept unpressed in the "protruded" position (tape-1), reproduction of a tape deck is feasible from TAPE-1 Monitor terminal (23). When it is depressed (tape-2), reproduction from TAPE-2 Monitor terminal (25). This is coupled to the Tape Monitor Button (7), therefore when reproduction from tape deck is required, it is necessary to depress the Tape Monitor Button.

## 9. Tape Reprint Buttons (DUBBING)

Tape dubbing is possible with these buttons. When the button "2-1" is depressed, the playback signals for DECK-2 terminal can be copied on DECK-1, and vice versa when the buttons "1-2" is depressed. While in the dubbing process, it is possible to monitor with the Tape Monitor Button. These two switches are independent push-ON/OFF type, and it is advisable to depress only the required button. When both of them are depressed simultaneously, the left "2-1" button operates. Except when reprinting a tape, it is recommended that these buttons should be kept unpressed at the "protruded" position.

This reprinting circuit is independent and reproduction of other sources as record or tuner is possible during tape dubbing.

## 10, 11. Treble Control

A clockwise turn of these knobs

10, 11. Treble Control

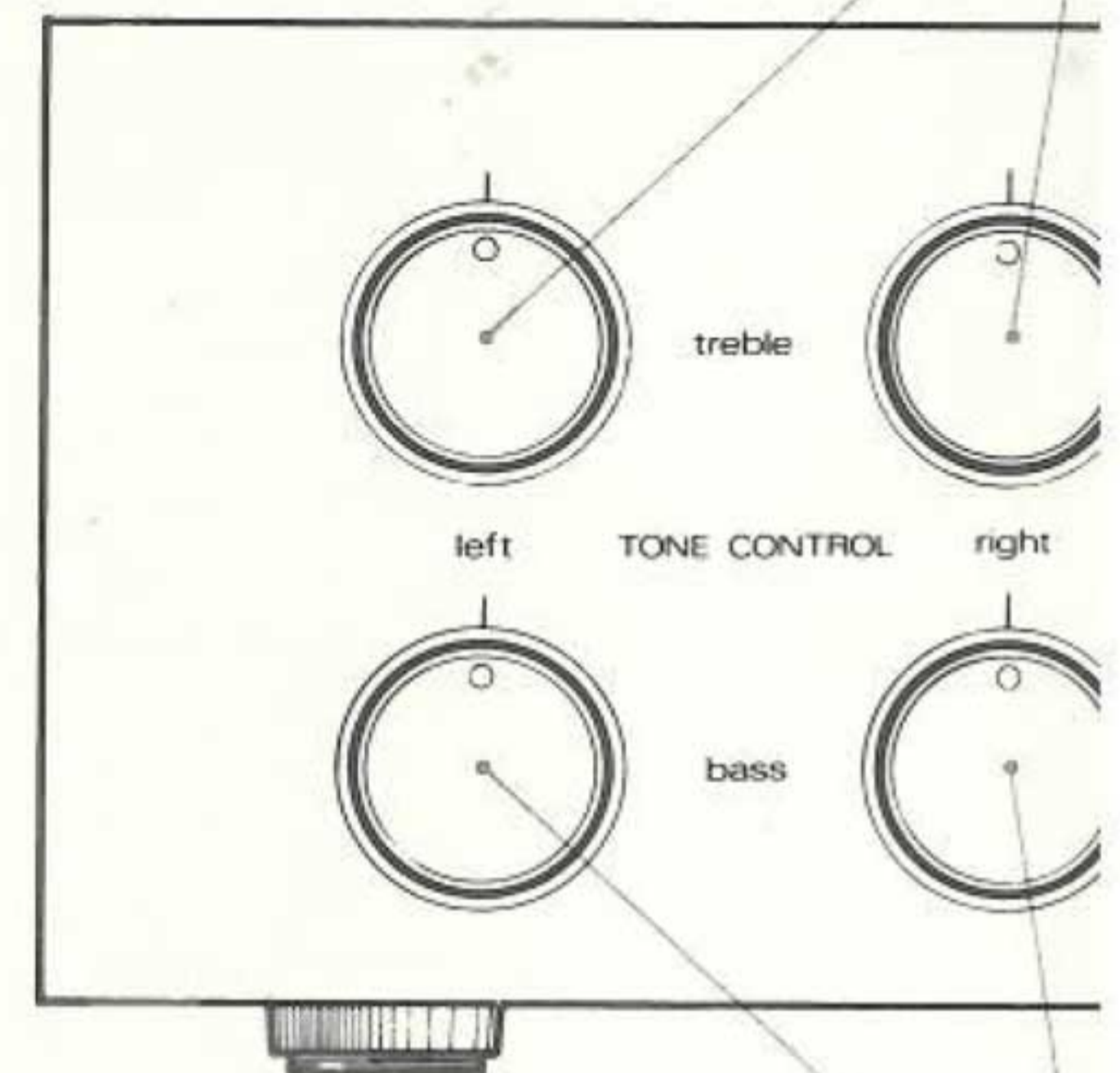

12, 13. Bass Control

boosts the treble response, while a counter-clockwise turn decreases the treble. The flat frequency response is obtained in the center of rotation angle. These level controls are independent, and permit separate control of both left and right channels. This is convenient for adjustment of different levels between both channels.

## 12, 13. Bass Control

A clockwise turn of the control boosts the bass response, and a counter-clockwise turn decreases the bass. It yields a flat frequency response when set to the center of rotation. These level controls are independent, and permit separate

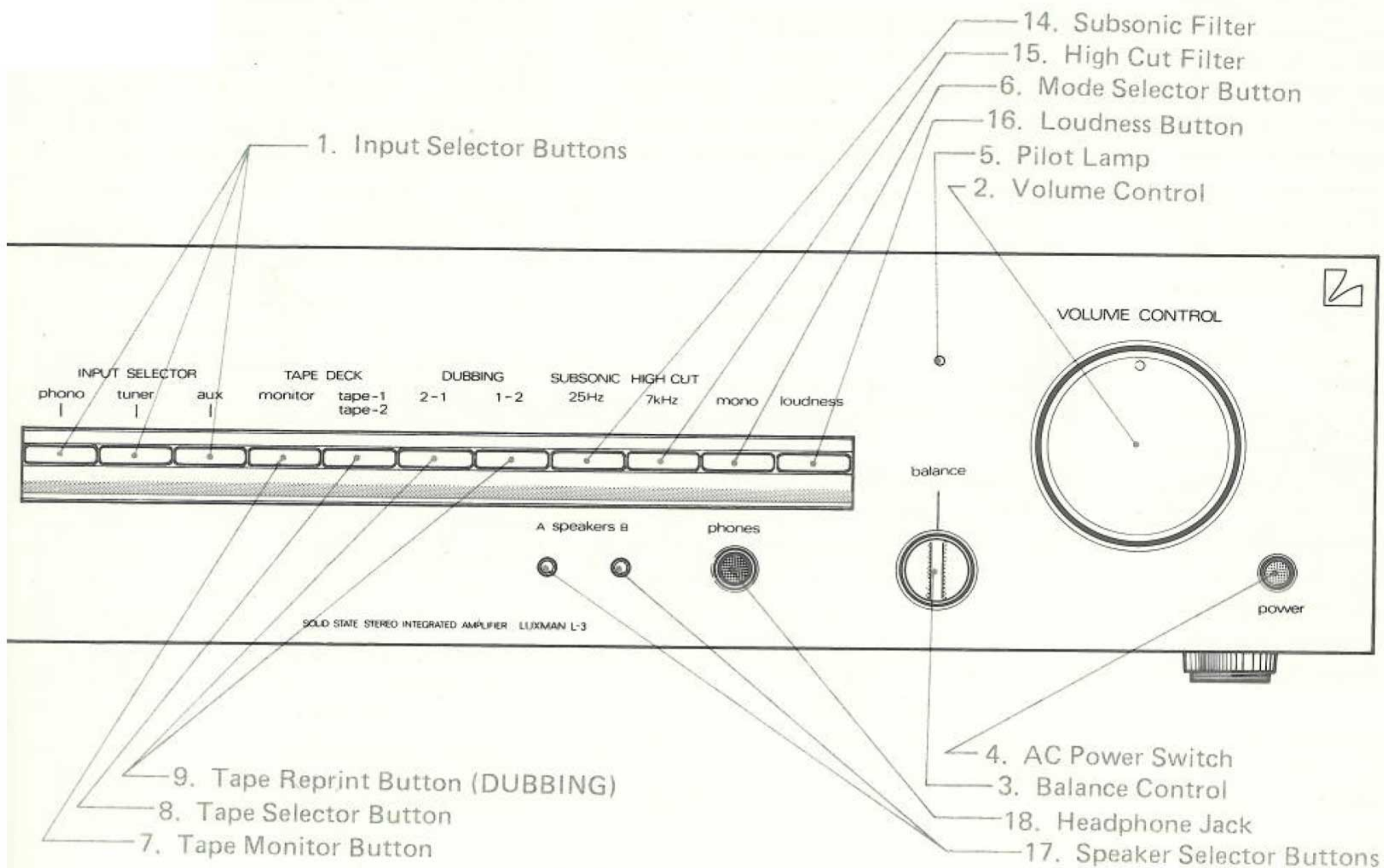

control of both left and right channels. This is convenient for adjustment of different levels between both channels.

#### 14. Subsonic Filter

When this button is depressed, a bass roll-off occurs at 25Hz at the rate of  $-6\text{dB/oct}$ . This filter eliminates ultra low frequency noises. For further details, refer to "Subsonic Filter".

#### 15. High Cut Filter

When this button is depressed, the amount of high frequencies is reduced at the rate of  $-6\text{dB/oct}$ . at 7kHz. Convenient to remove tape hiss, disc scratch noise, etc. For

further details, refer to "High Cut Filter".

#### 16. Loudness Button

When this button is depressed, compensation of low frequency and high frequency is realized according to the reproduction level. This is useful when listening at low level. Refer to the "Operation of Loudness" for further details.

#### 17. Speaker Selector Buttons

This amplifier offers convenient use of 2 speaker systems, A and B. You can choose independent or simultaneous driving of 2 systems by the two switch buttons. In the "protruded" position, the speakers

are disconnected from the amplifier, and you can enjoy private listening by headphone. Note that the impedance of each speaker system should exceed 8 ohms when you drive two speaker systems simultaneously since these two terminals are wired in parallel.

#### 18. Headphone Jack

Connection of a stereophonic headphone to this jack allows private listening. Output signal is always available regardless of the position of the Speaker Selector Buttons (17). For private listening, however, keep both of the speaker Selector Buttons unpressed in the "protruded" position.

**19. PHONO Terminal**

Output of a magnetic cartridge (MM, MI, MC type) can be reproduced through this terminal. Input sensitivity is 2.5mV. Input impedance is 50k ohms. Except for very low output MC type cartridge (output voltage, 0.01mV – 0.1mV), almost all cartridges can be used. For such MC type cartridge of very low output level, it is necessary to boost voltage up to the specified level by use of step-up transformers or a head-amplifier.

**20. TUNER Terminal**

This terminal is for playback of a tuner (AM/FM/LW/SW). Input sensitivity is 145mV. Input impedance is 50k ohms.

**21. AUX Terminal**

This is an auxiliary input terminal for playback of flat frequency response sources such as AM/FM stereo-tuner, line output of a tape recorder, or the audio output of a television receiver etc. Input sensitivity is 145mV. Input impedance is 50k ohms.

**22. Earth Terminal (GND)**

Connect the earth (ground) lead wire of the record player (from motor or pick-up arm) to ground the amplifier. Especially, when making A/B listening test, common earthing is effective for elimination of thump noises at the time of selecting amplifiers.

**23. Monitor-1 Terminal**

Playback of the line output of a tape recorder is possible from this terminal. It is put into operation when the Tape Selector Switch is in the "protruded" position and the Monitor Switch is depressed. In case a 3-head tape recorder is used, simultaneous playback monitoring is possible. Input sensitivity is 145mV. Input impedance is 50k ohms.

**24. REC. OUT-1 Terminal**

A signal for recording is taken out from this terminal (always available when an input signal is given to any of the input terminal).

In case the Dubbing Button "2-1" is depressed, the recording signals come from the DECK-2 monitor terminals.

**25. Monitor-2 Terminal**

This terminal offers the same function as the Monitor-1 terminal (23). It is put into operation when the Tape Selector Button and the Monitor Button are depressed.

**26. REC. OUT-2 Terminal**

This terminal offers the same function as the REC. OUT-1 terminal (24). If the Dubbing Switch "1-2" is depressed the signal from the DECK-1 terminal is available.

**27. Tape Connector for DECK-2**

This connector is of DIN standard. With the recording output terminal (REC. OUT) and the tape monitor terminal in it, connection for recording and playback is feasible with a single patch cord with DIN plug provided that the tape recorder has the same connector. For playback through this connector, both the Monitor and Tape Selector Buttons have to be depressed, since this connector is coupled to the DECK-2 terminal.

**28, 29. Speaker Terminals (A and B)**

The speaker systems should be connected to these terminals. Turn the cap of the terminal counter-clockwise and insert the bare speaker cord into the terminal hole, then fasten the cap tight. These terminals are coupled with the speaker buttons, and select the correct one corresponding to the terminal to which the speaker systems are connected. (28) is for the A speaker, and (29) is for B speaker. The red terminal is for (+) and the black for (-). For further details, refer to Connection of Speakers.

**30. Speaker Protection Fuse**

This fuse prevents the speaker from abnormal large current caused by malfunction of the L-3. Also it protects the amplifier itself in such case that the speaker terminals are short-circuited.

The fuse holder at the left is for the right channel and the one at the right is for the left channel. In case reproduction is suddenly impossible, this fuse must be suspected first. In this case, first disconnect the AC plug from the AC socket and check it. When it is blown, replace it with the one provided after ascertaining the cause. The fuse is fast-blow 3-amp type.

In CANADA, however, replacement of the fuse by yourself is not allowed by the CSA standard, therefore consult your LUXMAN dealer when it is blown.

**31, 32. Extra AC Outlet**

AC power supply to other audio equipment can be made through these outlets. The terminal (31, UNSWITCHED) is independent of the AC power switch of this amplifier, while the other (32, SWITCHED) is coupled to the power switch. The maximum capacity for the outlets is 100W respectively.

Note that in some countries these outlets are not allowed by law and that they are not provided.

**33. AC power Cord**

Connect the AC plug at the end of this cord to the AC power supply source in your listening room.

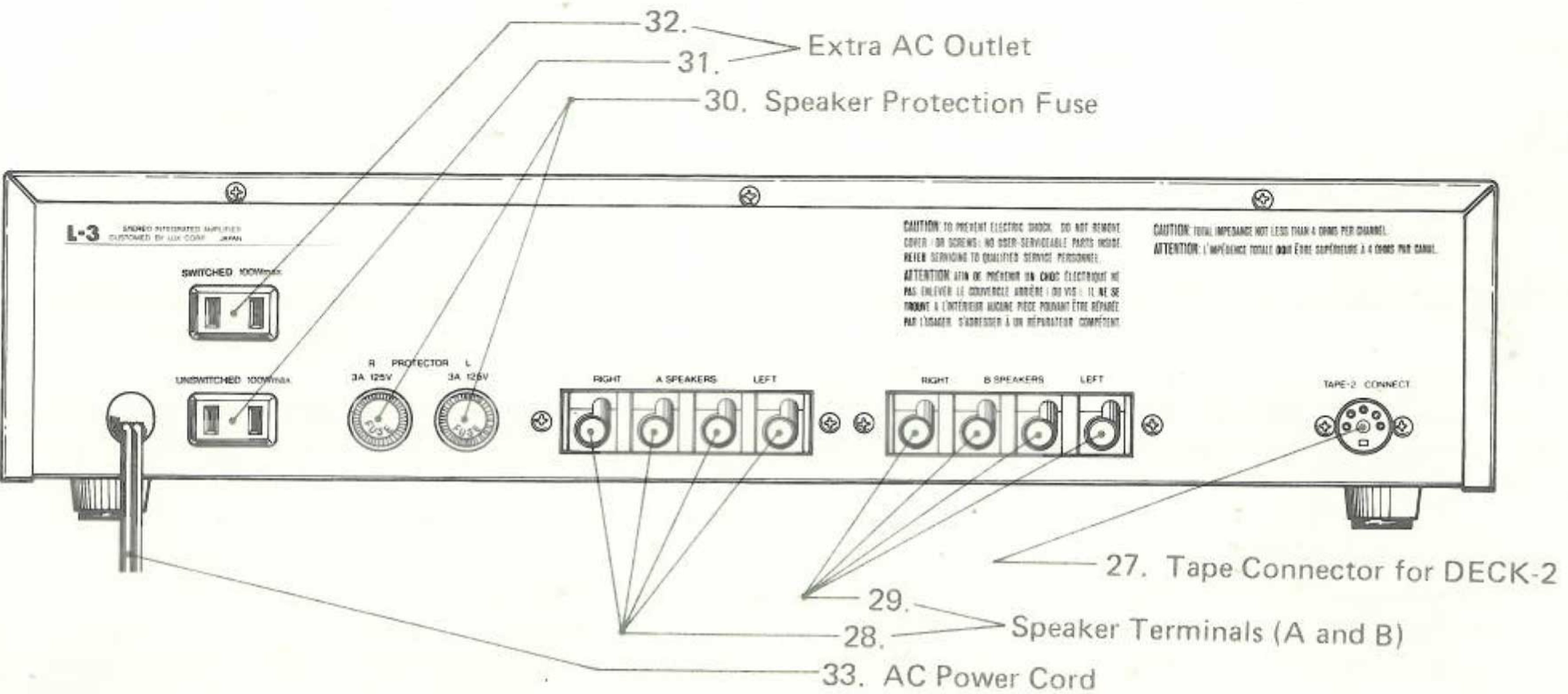
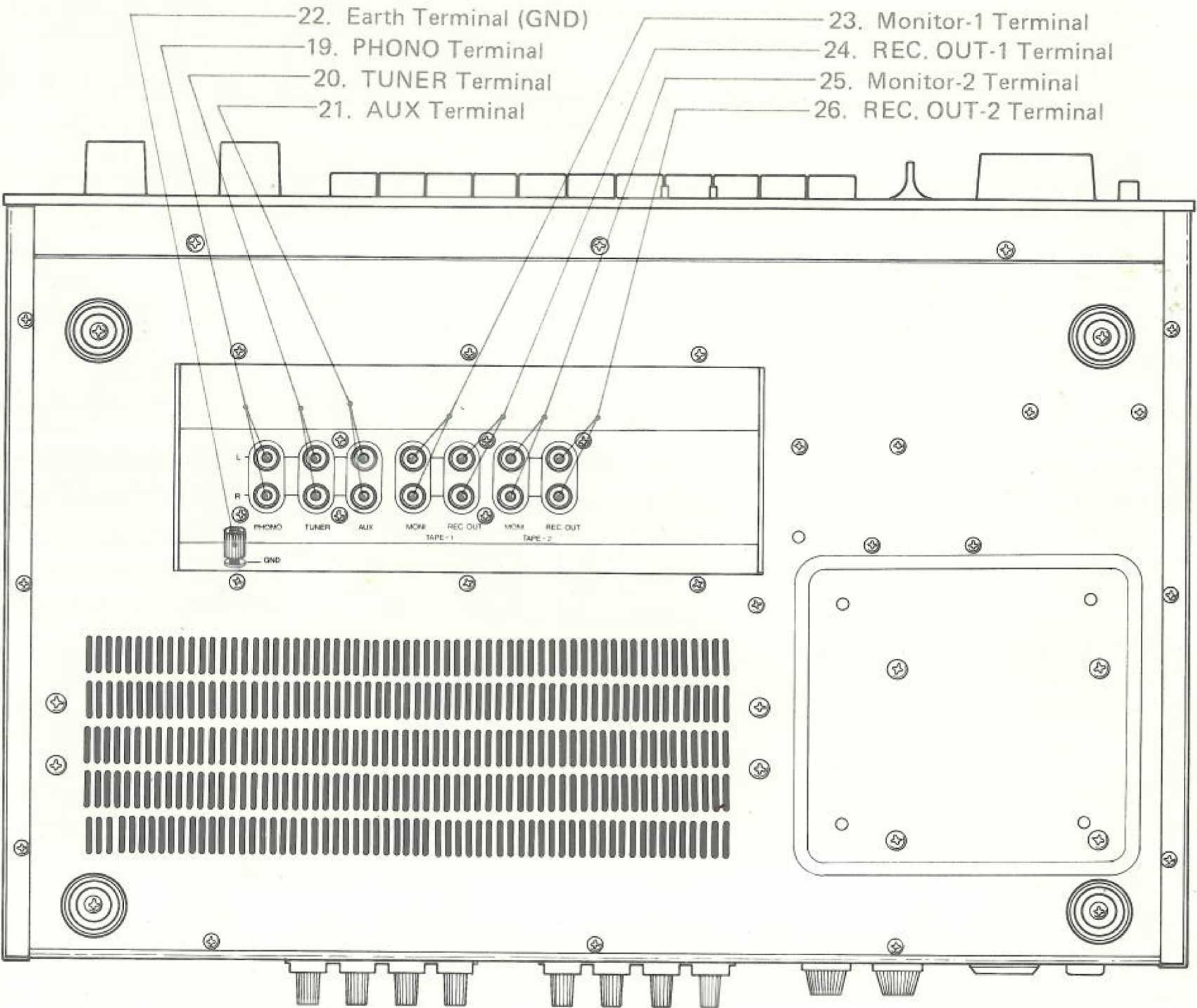

# CONNECTION & OPERATION OF RECORD PLAYER & TUNER

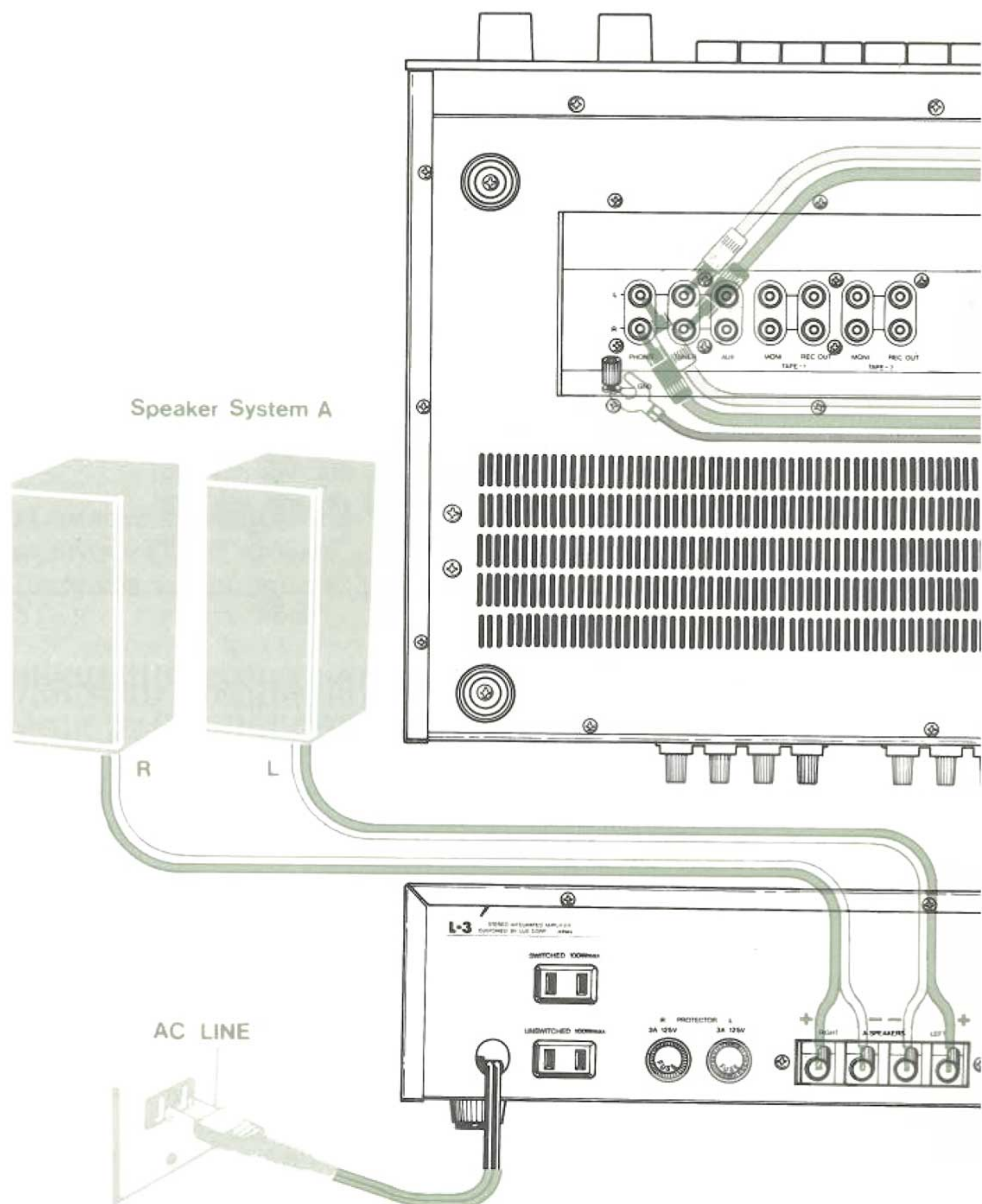



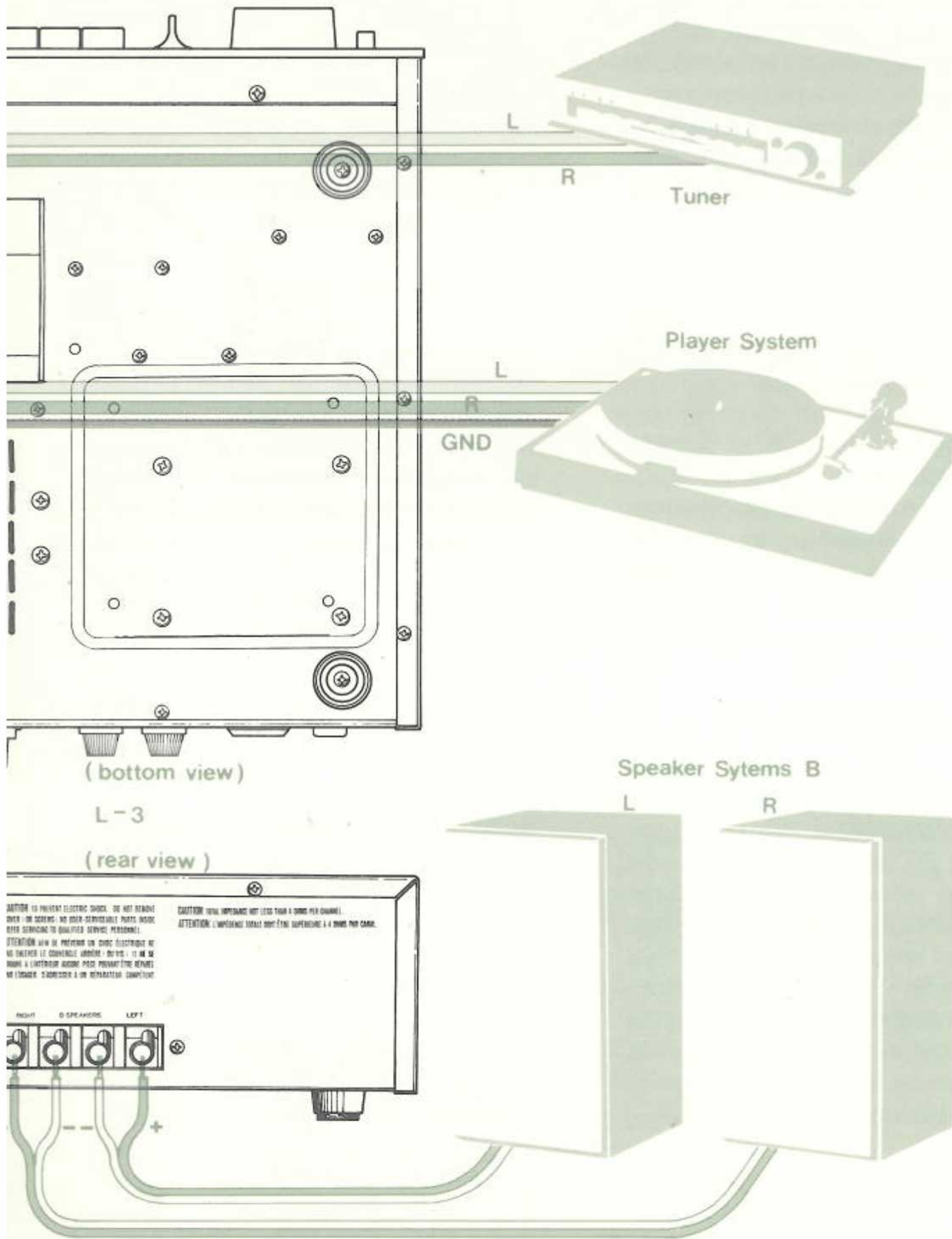

### About Connection Cable

For connection of record players, tuners and tape recorders, shielded wires are used to avoid possible influence from external noise or inductance noise. Usually, the shielded wire has capacitance of approximately 200pF per meter (3.3 feet) or has 35 ~ 100pF capacitance per meter at low level.

Adoption of a connection cord gives the same effect as that of insertion of a capacitor in parallel with input sources or output load equipment, which composes a kind of high cut filter circuit and causes an unneces-

sary attenuation of high frequency range. Of late output impedance for tuner/tape recorder has been so designed as to be sufficiently low, and there is almost no problem as in this case parallel composite impedance becomes lower and cut-off frequency will be shifted out of audible range. In the case of record player, however, output impedance value of popular MM type cartridge is approx. 10k ohms at 10kHz in general. Therefore choose a shield wire of good quality and use it as short as possible for connection of the amplifier.

### Connection of Record Player

A player has 2 cords with pin plugs at their ends for both right and left channels. Connect the pin plugs to the input terminals of this amplifier (PHONO). The player's earth lead can be connected to the GND terminal (22). The player's power flex can be connected either to the two extra AC outlets of the amplifier.

### Connection of Tuner

Connect the tuner's output terminals (left and right) to the Tuner terminals (20) or to either of the amplifier's AUX terminals (21). The Input Selector Buttons (1) must be set at the corresponding position. Connect the AC cord of a tuner to the Extra AC Outlet (SWITCHED) (32) of this amplifier, and leave the power switch of the tuner turned on. In this case, when the AC power switch (4) is turned on, the AC power of the tuner is turned on at the same time.

### Connection of Speakers

Stereophonic playback is made with a pair of speaker systems for right and left channels. This amplifier is provided with 2-channel terminals for main and remote speakers. Connection can be made in the same manner. The right speaker system should be connected to the Right speaker terminals, and the left speaker system to the Left terminals.

Note that perfect sound reproduction cannot be expected if the phase is not matched between both channels. To match the phase is to connect the (+) terminal of the right speaker to the (+) terminal (red cap) in the right channel of this amplifier, and the (-) terminal to the (-) one (black cap). Do the same with the left speaker. If mismatched for some reason (e.g. misconnection of speakers), the low frequency range is subdued and stable playback cannot be realized.

Speaker cord is not supplied with the L-3. However, special speaker cables are available from LUX as optional accessories. Six variations

are available in LUXMAN speaker cable, for general use WA103 (3m), WA105 (5m) and WA110 (10m), while for high output use WB103 (3m), WB105 (5m) and WB110 (10m). Coaxial type which suppresses the amplitude distortion caused by the surface effect and the inductance of cable itself, of course each type is of low impedance type and accepts large current drive.

It is advisable to use speaker cords of big and good quality and make them short as possible even in case you use other speaker cords.

### Connection of AC Power Supply Source:

As the final step of preparation, connect the amplifier to the AC power supply source. The end of the AC power cord should be plugged into the power supply outlet. Then press the power switch.

### "Operation Procedure"

- (1) Depress the AC Power Switch (4) to turn the power on, and the Pilot Lamp (5) lights up. 15 - 20 seconds later the unit is put into perfect operational condition. Operation of each control should be done after this condition is established. Note that a slight thump noise may be triggered at the time of turning the power switch on, which is not abnormal.
- (2) Press in one of the Input Selector Buttons to which the program source you are going to reproduce is connected. When reproduction from disc is required, depress the "phono" button, and for that from tuner, depress the "tuner" button, etc.
- (3) Press in either of the two Speaker Selector Buttons. When the speaker system is connected to the "A" terminal (27), depress the "A" button, while when it is connected to the "B" terminal (28), depress the "B" button. It is easy to select system-A or

system-B when two pairs of speaker systems are connected. Also, in case both of the buttons are depressed, "A+B" operation of the speaker system is feasible. At this time, note that the impedance of each system should exceed 8 ohms at least.

If reproduction is not possible, check above mentioned (2) and (3). The input selector (1) or the Speaker Selector (17) may not be correctly selected. Also, check if the Monitor Button (7) is in the "protruded" position.

Now, check both of the right and left speaker system are all right, and the balance of reproduced sound. If reproduction is possible only from a single channel, check the position of the Balance Control (3). Normally, this control should be in the center click position. Also connection of the input-side equipment or the output-side equipment should be rechecked.

Remember to set the Mode Selector Button to the "protruded" (stereo) position, otherwise stereophonic reproduction is not feasible even if the program source is in stereo mode.

### Signal Paths

First, the signals fed to the amplifier through PHONO terminals (19) are brought to the equalizer section, where recorded signals are restored to the original frequency curve. Incidentally, this equalizer curve has been standardized to the RIAA curve. The equalized signals are then fed to the Input Selector Buttons (1). The signals fed to the TUNER terminal (20) are directly fed to the Input Selector Switch. If this button is not depressed at the time of disc reproduction, the signals are blocked here and no amplification is possible. The same can be applied to the TUNER reproduction.

After the input selector button, one line goes to the REC. OUT terminal, and the other to the Tape Monitor Button (7). If the Tape Monitor Button is in the "protruded" (source) position, the signals are sent to the mode selector button,

balance and volume controls but if it is depressed, the signals are stopped at the tape monitor terminals. Except during tape playback, the monitor button must be kept in the "protruded" position. But when the input signals are fed to PHONO, TUNER or AUX terminals, recording output is always obtainable regardless of the position of the monitor button.

Then signals passed through the tape monitor button are sent to the Volume Control (2) via Filters (14)(15), Mode Selector (6), Balance Control (3), and Loudness Control (16). In case the volume control is turned to the most counter-clockwise position signals are blocked here, therefore it is necessary to set it to an appropriate sound level. The balance Control compensates the level-difference between the chan-

nels, and when it is in either of the extreme positions, no sound reproduction is possible at the other channel. Therefore, this control should be in the center click position.

The signals are thus fed to the power amplifier section from the pre-amplifier section via the flat amp section, which includes tone control circuit, where signals are amplified up to the level that is necessary for the power amplifier section. In the power amplifier, signals are wattage-amplified to drive the speaker systems, and fed to the Speaker Selector Buttons (17). This button selects speaker system connected to the two Speaker Terminals. When the button to which the speaker system is connected is depressed, reproduction is feasible from the speaker system.

For your pleasant command of this amplifier, we recommend that you bear the blockdiagram in your mind.

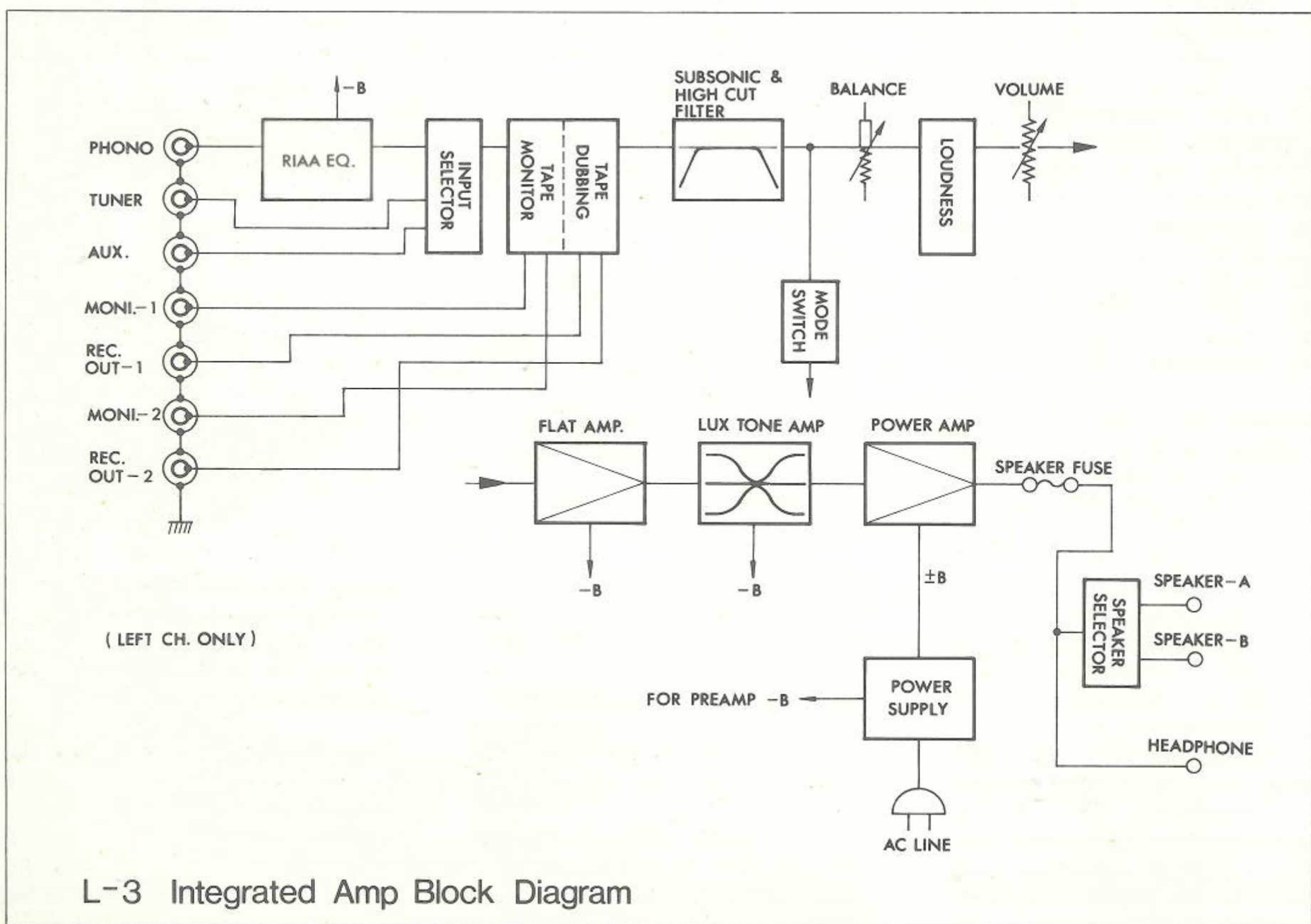

# CONNECTION & OPERATION OF TAPE DECK

## Playback from Tape Monitor Terminals:

Almost all tape recorders and tape-decks currently marketed include an audio amplifier in their circuitry, and some tape-players are made exclusively for playback.

Connect the output terminal (LINE OUT) to a Tape Monitor terminal (23) or (25). Depress either of the two Tape Selector Buttons to which the required tape deck is connected. Then, also depress the Tape Monitor Button.

This amplifier can be divided into two sections; one before the Recording Output terminals (REC. OUT) and the other after the Tape Monitor Button. A 3-head tape recorder makes it possible to make recordings with the former section and simultaneously make playback with the latter section.

Note that a normal function cannot be expected if 2 sets of tape recorders for playback are connected to the terminals of Monitor-2 Terminal (25), and Tape Connector (27) at the same time, since these two are coupled in the inside circuit and affect each other. Therefore, if the Tape Monitor terminals and the Tape Connector are used, the tape-recorders should be connected to the terminals of Monitor-1 terminals (23) (with the Tape Selector button in the "depressed" position) and to the Tape Connector for DECK-2.

## Playback from AUX Terminals:

Playback of tape is possible if the line output of the tape-recorder or tape deck is connected to the AUX terminal of this amplifier by use of a pin-jack lead, and the Input Selector Button "aux" is depressed. All operations in this case are the same as those for the playback from tuner (page 7).

Note that when tape playback is made through the AUX terminals, the line input or AUX input terminals of the tape should be kept free. If connected to the Recording Output terminals (REC. OUT) of the amplifier, there will be possible oscillation by feedback of signals.

## Simultaneous Playback Monitoring:

A 3-head tape recorder ensures simultaneous playback monitoring and recording. In this case, recording on tape and playback of the recorded sound is done at the same time, and connections must be made for both functions. It is necessary to connect the REC. OUT terminals to the line input terminals (AUX input) of the tape deck and the Tape Monitor terminals to the output terminals (LINE OUT) of the tape deck.

Repetition of switching between "protruded" position and "depressed" position of the Tape Monitor Button makes it feasible to compare the original sound with recorded one. Thus possible recording error can be prevented in case of 3-head tape recorder. Incidentally note that reproduction of recorded sound becomes a little bit delayed as compared with that of original sound since there is a gap between recording head and playback head. Simultaneous playback monitoring can be made through the Tape Connector (27) as well. A single DIN patch cord ensures connection for recording and playback.

## Playback from Tape Connector:

This is a DIN connector and is convenient for simple connection with a patch cord between the tape recorder and recording/playback connectors of this amplifier. Playback from the Tape connector is possible if both of the Tape Monitor Button and the Tape Selector Button is depressed.

## Recording on Tape:

In case of playback of various program sources through input terminals of this amplifier, the same signals as those reproduced in the speakers are always available at the REC. OUT terminals and the Tape Connector. By connecting these terminals to the input terminals (AUX or LINE IN) of the tape recorder, you can enjoy simultaneous recording and playback. These recording signals are taken out

before the tape monitoring stage, and there is no influence on the filters, volume or tone controls, etc., as far as the quality of the recorded signals is concerned.

## Tape Dubbing (REPRINTING):

With this amplifier, it is possible to reprint from one tape-recorder to another. Connect the line output terminals and the line input (or AUX) terminals of one tape-recorder to the TAPE-1 Monitor and REC.

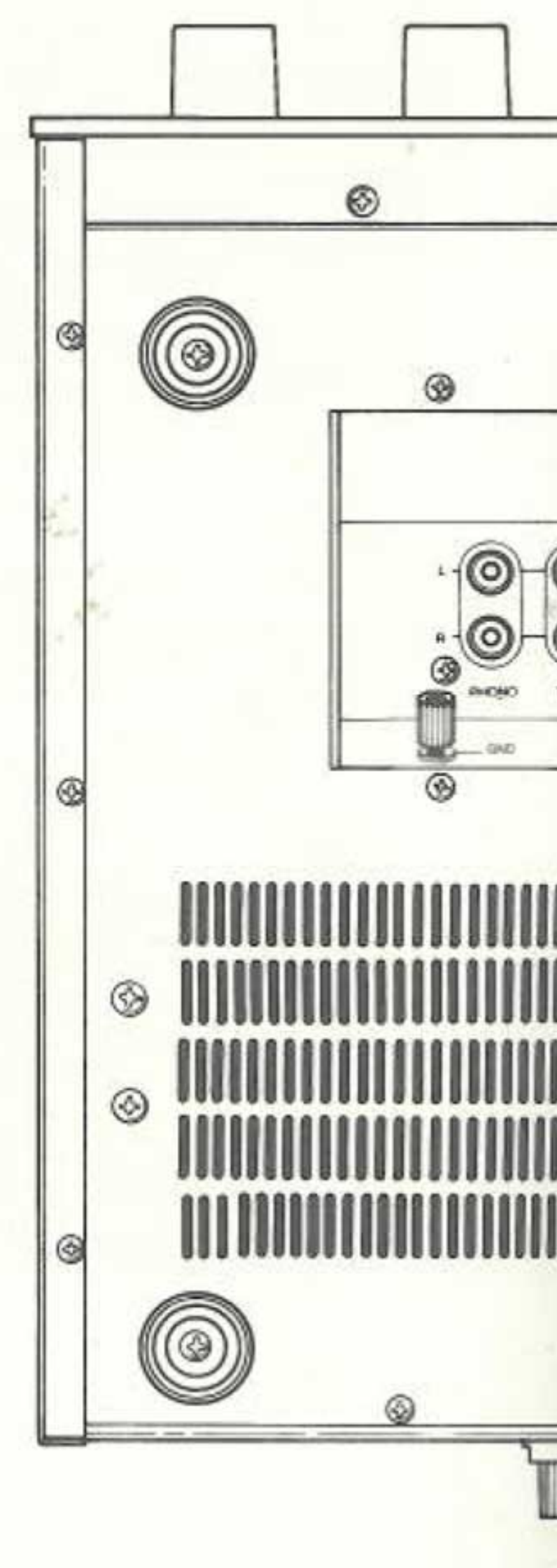

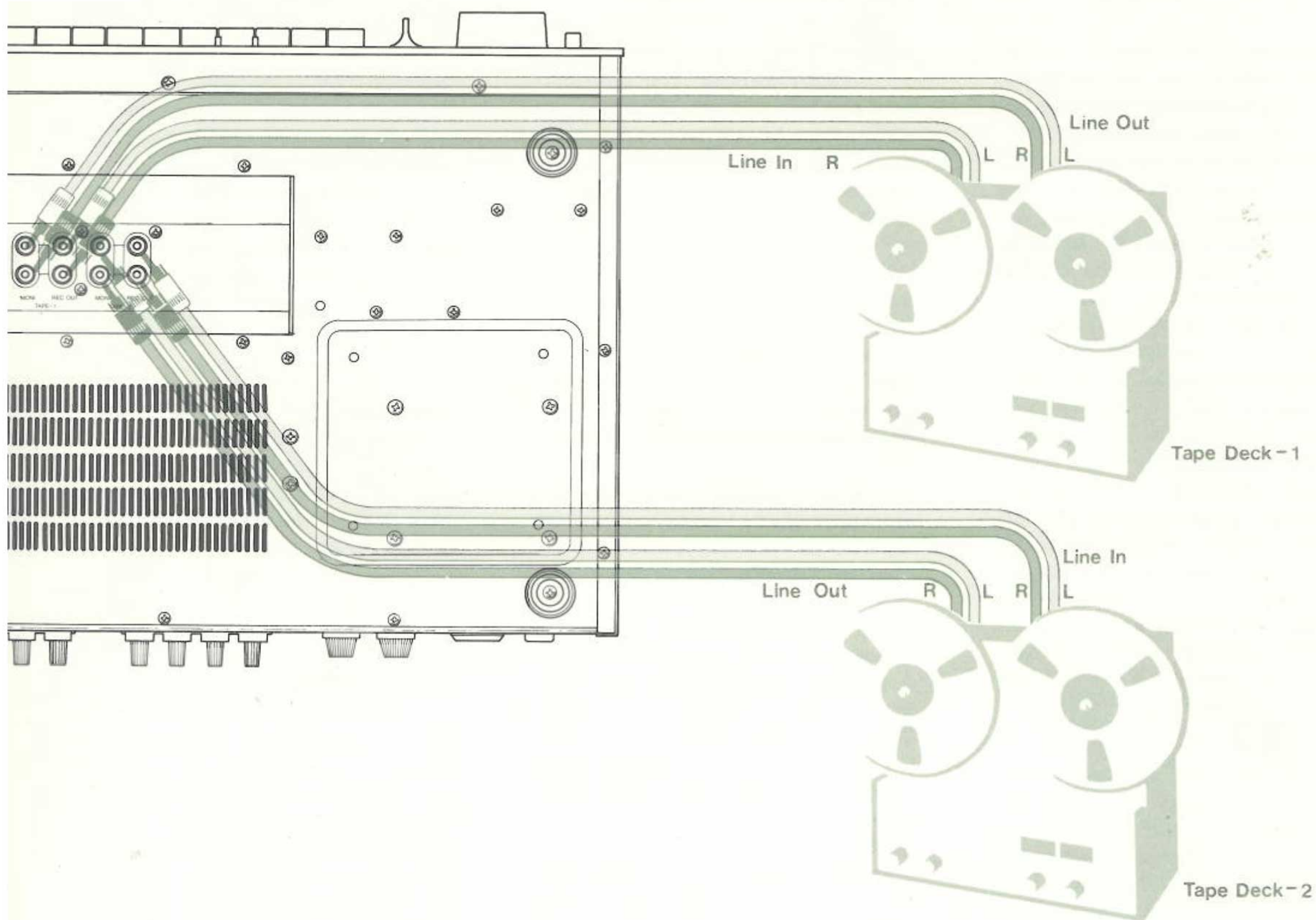

OUT terminals of the amplifier respectively. Likewise, connect the line input and output of the other tape-recorder to the TAPE-2 Terminals.

For reprinting from tapedeck-1 to tapedeck-2, depress the "1-2" button of the Tape Dubbing Switch while for that from tapedeck-2 to tapedeck-1, the "2-1" button should be depressed. At this time, switching of tape selector switch (7) between "tape-1" and "tape-2" makes it

possible to compare the master tape and the reprinted tape recording.

The dubbing circuit is independent of the main signal paths, and disc or tuner reproduction is feasible in the course of tape dubbing operation when the Tape Monitor Switch is in the "source" position.

**Simultaneous Recording:**

This amplifier is provided with 2 sets of Recording Output terminals (24, 26) enabling to record simul-

taneously on 2 tape-recorders. In this case connection should be made in the same manner as that described in the "Recording on Tape"

Note that when the "1-2" button is depressed, the recording output is available only at the REC. OUT-2 terminal. While when the "2-1" is depressed, output is available only at the REC. OUT-1 terminal.

# OPERATION OF CONTROLS

## Volume Control:

This knob controls volume. Clockwise turn boosts volume, while counter-clockwise decreases until it is inaudible. The variable resistor of this control has a logarithmic curve. In the attenuation characteristics of A type, the turning angle is proportionate to the attenuation degree (dB), the dB value and the volume audible to human ears are in proportionate relation. In other words, the rotation of the control is in proportion to the sound volume felt by human ears. The increasing degree of volume is felt quite natural as the control is turned in the clockwise direction.

## Balance Control:

In case deviation is felt between the volume levels of right and left channels, adjust the unbalanced volume level with this control (3). A complete turn of the control to either the clockwise or counter-clockwise direction causes a cut-off of the volume of the other speaker. The volume balance of both channels can be adjusted so that monaural disc sound reproduced by the stereo cartridge comes from the center of the right and left speakers. At mid position, the volume of both channels is adjusted to the same level. Thus, a proper balance is established throughout all playback stages. If a program source is unbalanced (or the speakers are placed in an oblique position), establish the correct balance with

this control.

## Tone Controls:

The purpose of the audio system is to make high fidelity reproduction of program sources. The reproduction and acoustic conditions do not always match with recording conditions, and it is impossible to reproduce the same sound as the original. Also, there is no objective standard to judge a good sound from an inferior one. The only possible solution is for every listener to create his favorite sound according to his own taste. It is therefore very important that the audio system offers a facility to permit flexible controls for creation of the best sound.

This amplifier is equipped with tone controls for subtle and minute control of the reproduced sound such as Bass Control (12, 13) and Treble Control (10, 11). Bass Control is a tone control on frequency response of low frequency range. It is designed so that response is flat at the electric center point, and a clockwise turn of the knob intensifies low frequency range while counter-clockwise turn yields attenuation.

Treble control is a tone control on frequency response of treble frequency range. It is designed so that response is flat at the electric center point, and a clockwise turn of the knob intensifies high frequency range while counter-clockwise turn yields attenuation.

## Operation of Loudness:

Because loudspeakers and ears generally respond less to extreme high and low (treble and bass) frequencies as volume levels are reduced, the Loudness button is included to boost these frequencies and thereby provides tonal compensation. Whether or not you use this switch depends upon the levels at which you generally listen, the kind of speakers you have, the room acoustics and a number of other variables. Experimentation is the best guide to using the Loudness button.

## High Cut Filter:

When this filter (15) is depressed the amount of high frequency range over 7kHz is cut off at the attenuation rate of  $-6$  dB/oct. This filter is useful for removal of scratch noise, hissing noise of tape etc. Also this can be used as an auxiliary control for Treble Control.

## Subsonic Filter:

Ultra low frequency noises (5 – 50Hz) caused by record warps, tonearm's resonance, phonomotor's rumble and acoustic feedback etc., are harmful in reproduction even if they are out of audible range as they produce intermodulation distortion by vibrating the cones of loudspeakers.

To remove such harmful ultra low frequency noises with the least effect on the audible frequency

L-3 BASS CONTROL (INPUT; AUX, OUTPUT; SP.T.)  
VOLUME; MAX, 8Ω LOAD

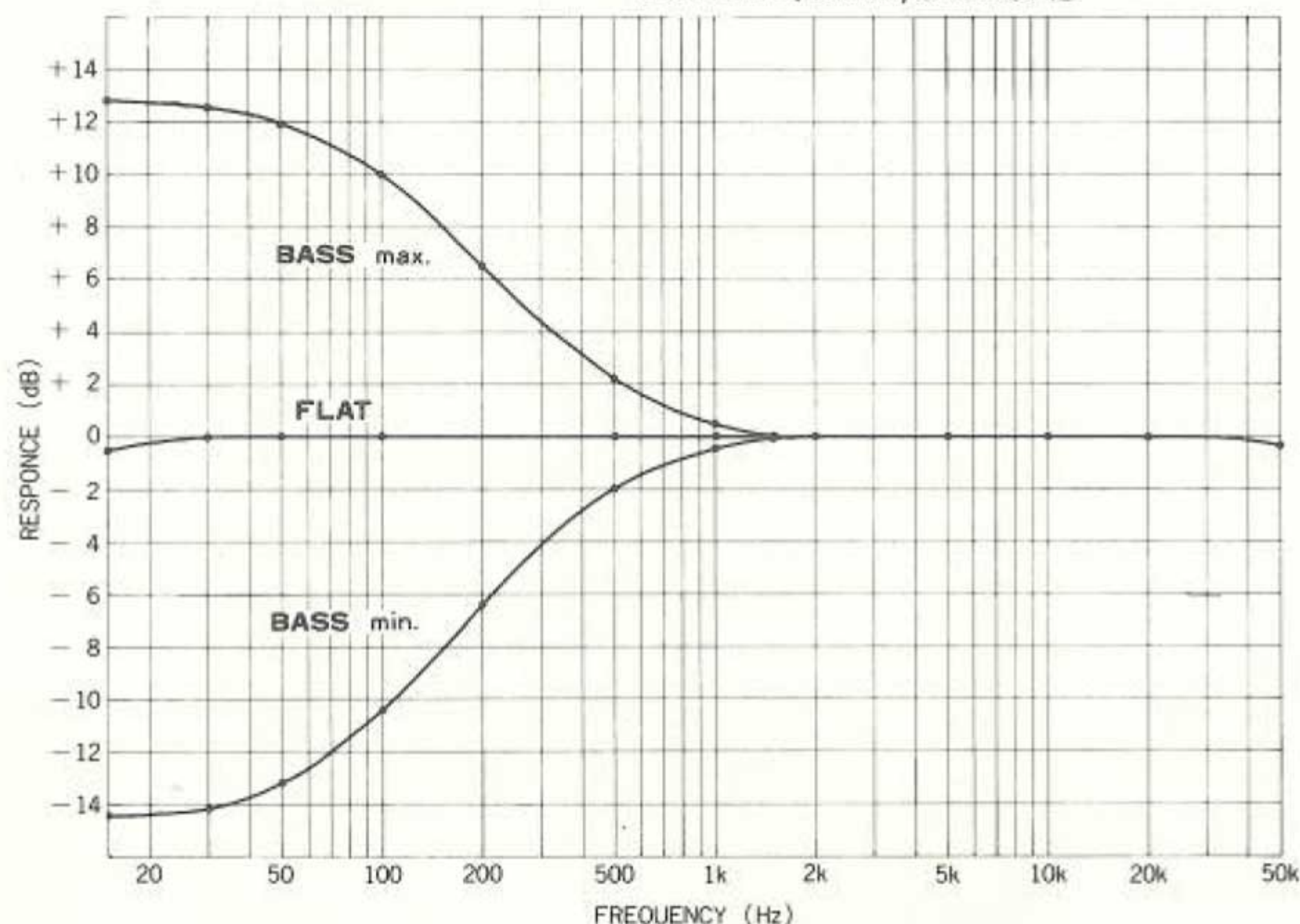

L-3 TREBLE CONTROL (INPUT; AUX, OUTPUT; SP.T.)  
VOLUME; MAX, 8Ω LOAD

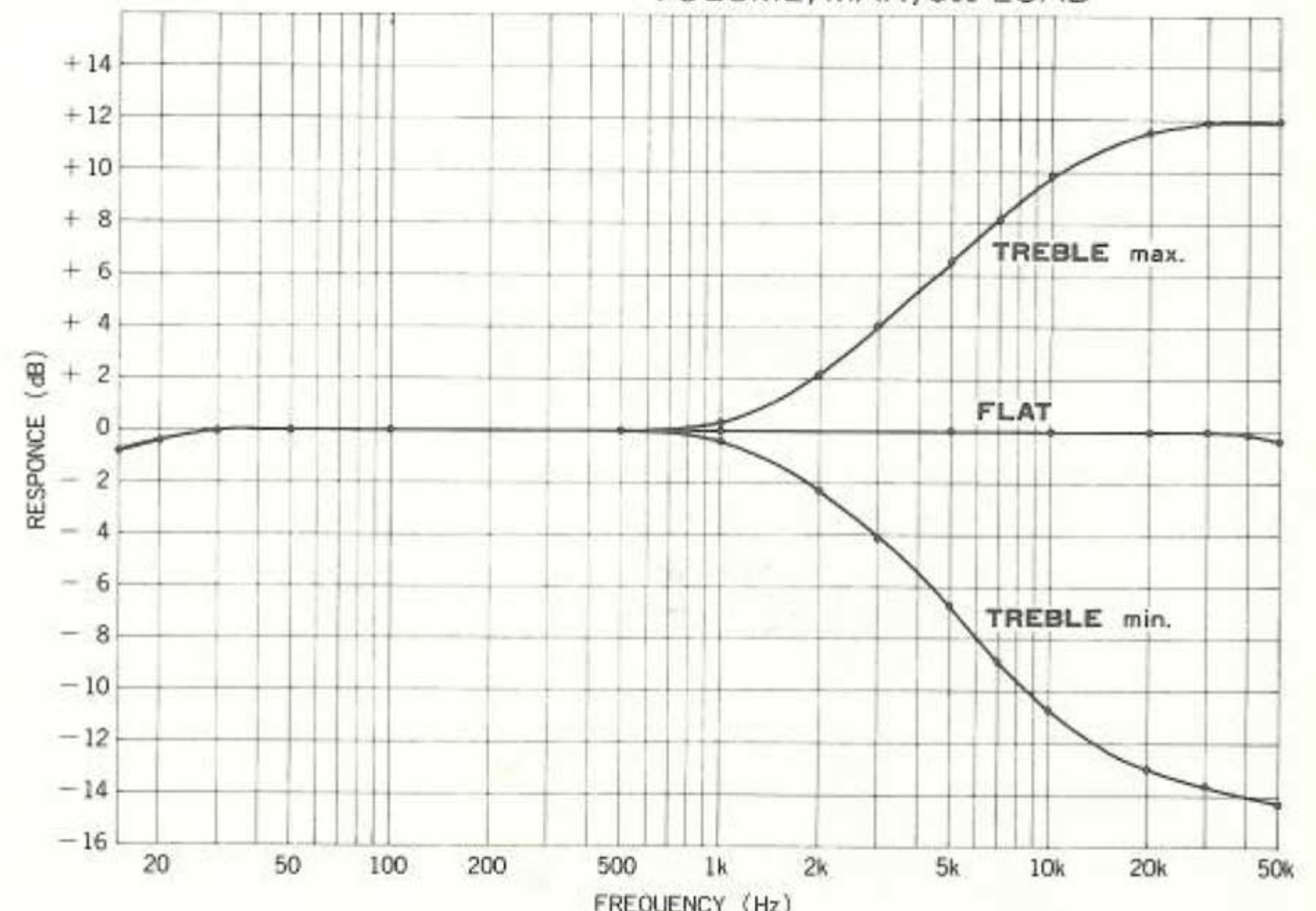

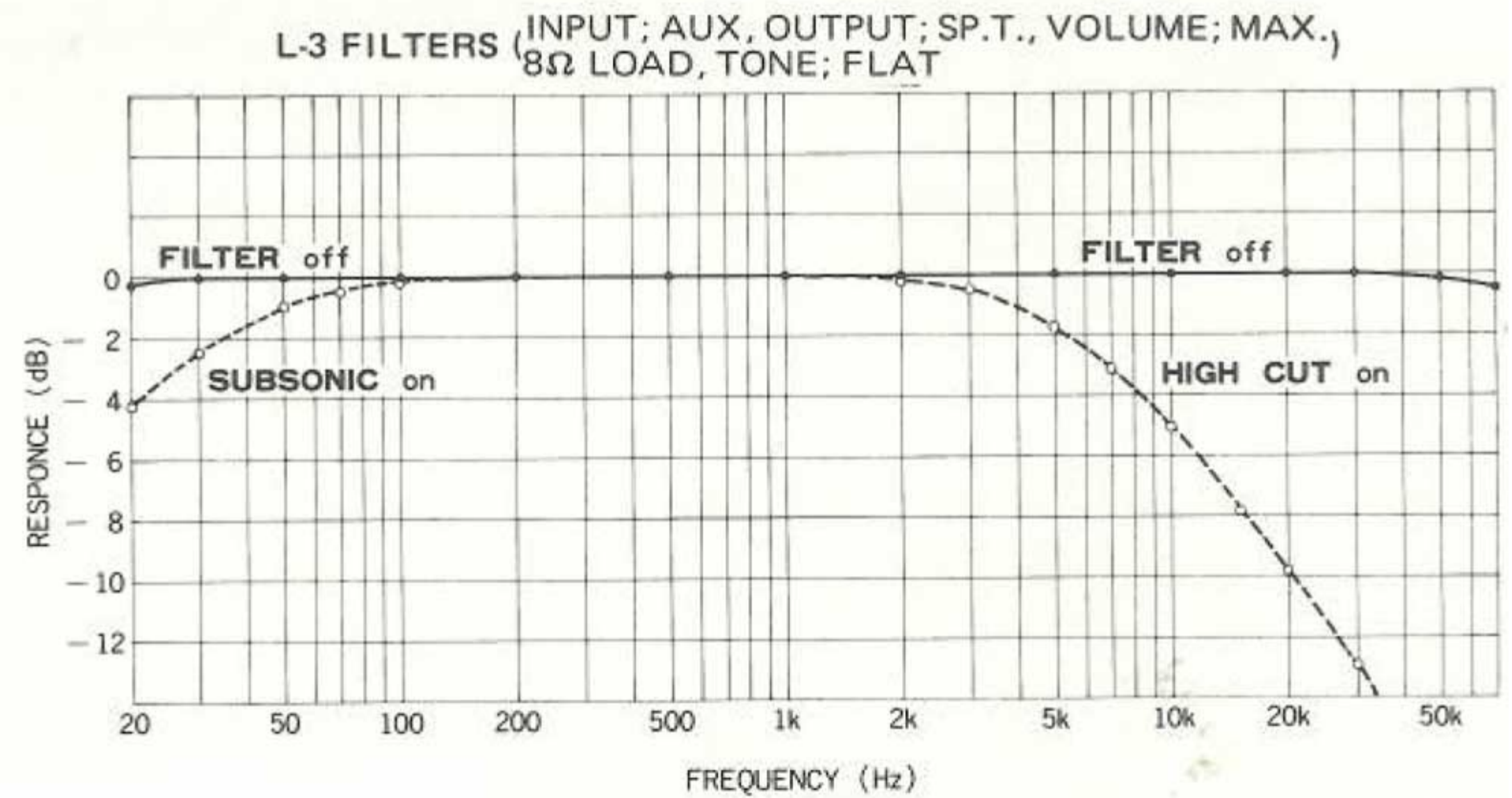
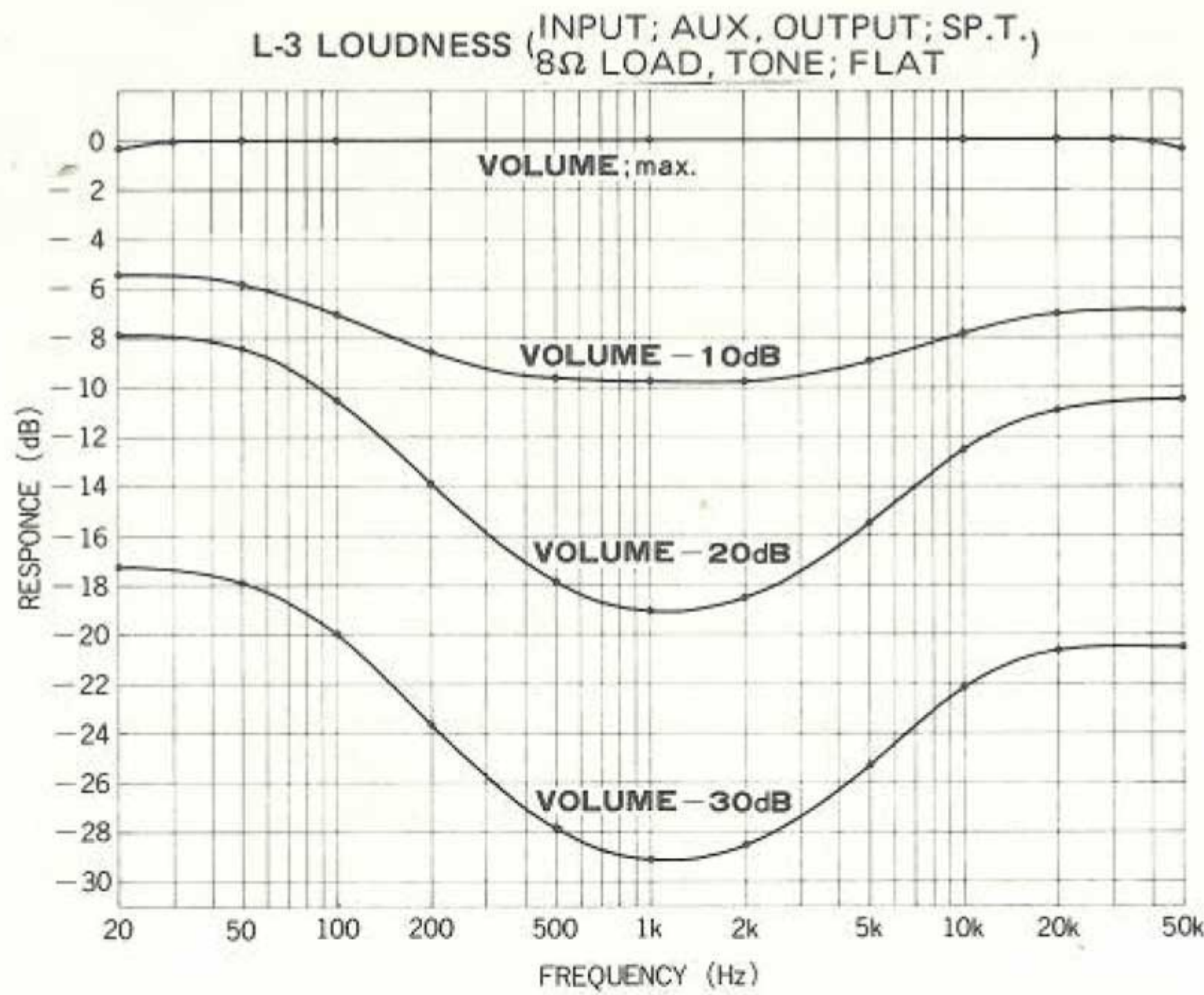

range, this unit is provided with the Subsonic Filter.

When the button (14) is depressed, noises below 25Hz are reduced at the rate of  $-6\text{dB/oct}$ . This filter lowers the frequency response below audible frequencies, therefore it does not affect the balance of program source.

In the "protruded" position, the filter is bypassed to realize flat frequency response.

left channels, or when stereophonic signals are to be reproduced in the monaural mode (e.g., to check the volume balance between the right and left channels). In this position you may use either of the right and left inputs.

### Mode Selector:

This amplifier is for stereophonic reproduction and incorporates independent amplifiers for two channels (right and left). Without the Mode Selector, the signals fed to the right channel terminal are reproduced at the right channel speaker only. The Mode Selector is placed between the two amplifiers to change the mode of reproduction

When the button is in the "protruded" position, the two amplifier channels function independently to ensure normal stereophonic reproduction, i.e., the signals fed to the right input terminal are reproduced at the right channel speaker and the input into the left channel is realized for reproduction at the left channel speaker.

On the contrary, when it is depressed, the signals of the two amplifier channels are mixed together to effect monaural reproduction. This position is useful when monaural signals are fed to both right and

# BEFORE CONSULTING A SERVICE SHOP

The L-3 integrated amplifier is classified into the "component" category, where one finds interest of making combination of the equipments. Therefore, to make the most of this system, firm and correct connection between the equipments, namely, record player, tuner, amplifier, or speaker systems etc., is absolutely indispensable. Further, desired reproduction of the program source may not be obtained unless correct operation of each equipment is done.

It may be possible that some knobs or switches are accidentally operated, or some connections are detached. In some cases, these are liable to be taken as troubles. Therefore, it is advisable to make fundamental check by use of the "Trouble Shooting" listed below.

When you find the trouble is not cured by this procedure, contact your nearest service shop.

		CAUSE	MEASURES
SYMPTOM	Pilot lamp does not light up when AC Power Switch is turned on.	<ul style="list-style-type: none"> <li>● AC plug is not connected to the AC socket, or may be loose at the socket.</li> </ul>	<ul style="list-style-type: none"> <li>● Connect firmly AC Power Cord to the AC power supply point.</li> </ul>
	Pilot lamp lights up, but both channels are silent.	<ul style="list-style-type: none"> <li>● Speaker Selector Buttons are "OFF" (protruded).</li> <li>● Speaker Protection Fuses (both channels) are blown.</li> <li>● Short-pins are inserted to the REC. OUT terminals.</li> <li>● Monitor Button is depressed.</li> <li>● Output level volume at tuner or deck are set in the "min." position.</li> <li>● Input Selector Button is misselected.</li> <li>● Firm connection of speaker cord, input or output pin-plugs etc. is not obtained.</li> <li>● Volume Control is set in the "min" position;</li> </ul>	<ul style="list-style-type: none"> <li>● Depress a Speaker Selector Button. Of course speaker should be connected to the corresponding point.</li> <li>● Check the Speaker Protection Fuse Holder, and replace the fuse when blown.</li> <li>● Remove the short-pins, and keep them.</li> <li>● Set the Monitor Switch at the "protruded" position.</li> <li>● Set the Output Level Control to an appropriate level.</li> <li>● Reset the Input Selector Button.</li> <li>● Check all the connections among audio equipments, and make it firm.</li> <li>● Rotate the Volume Control until the desired level is obtained.</li> </ul>
	One channel is silent.	<ul style="list-style-type: none"> <li>● Balance Control is set either in the extreme clockwise or counterclockwise position.</li> <li>● One channel of the speaker cord is detached, or short-circuited.</li> <li>● One of two Speaker Fuses is blown.</li> <li>● One channel of the connection cord of input equipment is detached.</li> </ul>	<ul style="list-style-type: none"> <li>● Set the Balance Control in the center click-stop position.</li> <li>● Make a firm connection of the speaker cord at the mute channel.</li> <li>● Replace the fuse with the spare one provided.</li> <li>● Connect the pin-plug firmly.</li> </ul>
	One channel is silent at the time of TUNER reproduction.	<ul style="list-style-type: none"> <li>● Pin-plug cord is connected to the Multipath detection terminal.</li> </ul>	<ul style="list-style-type: none"> <li>● Connect the pin-plug to the output terminal of the tuner.</li> </ul>
	Hum noises are notable.	<ul style="list-style-type: none"> <li>● Ground-side of the pin-plug does not firmly contact the terminal.</li> <li>● Shielded wire is not used for the connection cable among equipments.</li> <li>● Ground lead from the record player is not connected to the Ground Terminal of the L-3.</li> <li>● Installation of the cartridge to the shell, or that of the shell to the tonearm is insufficient.</li> </ul>	<ul style="list-style-type: none"> <li>● Check connection among cartridge, shell and tonearm, and instal firmly.</li> <li>● Use the pin-plug cord of shielded wire.</li> <li>● Connect the earth lead wire of the record player firmly to the GND terminal.</li> <li>● Check connection among cartridge, shell, and tonearm, and install firmly.</li> </ul>
	Program source in stereo mode is reproduced in mono.	<ul style="list-style-type: none"> <li>● Mode Button is depressed.</li> </ul>	<ul style="list-style-type: none"> <li>● Set the Mode Button to the "protruded" position.</li> </ul>

**Note:** The short-pins provided should be inserted to the PHONO input terminal unless the record player is connected to the terminal, otherwise following phenomena might occur.

- 1) Noises are remarkable when the "phono" Input Selector Button is depressed.
- 2) Click-noise will be triggered at the time of switching the Input Selector Button from "tuner" or "aux" to "phono".
- 3) Reproduction sound of tuner is heard even when the "phono" Input Selector Button is depressed.



# STANDARD CURVES

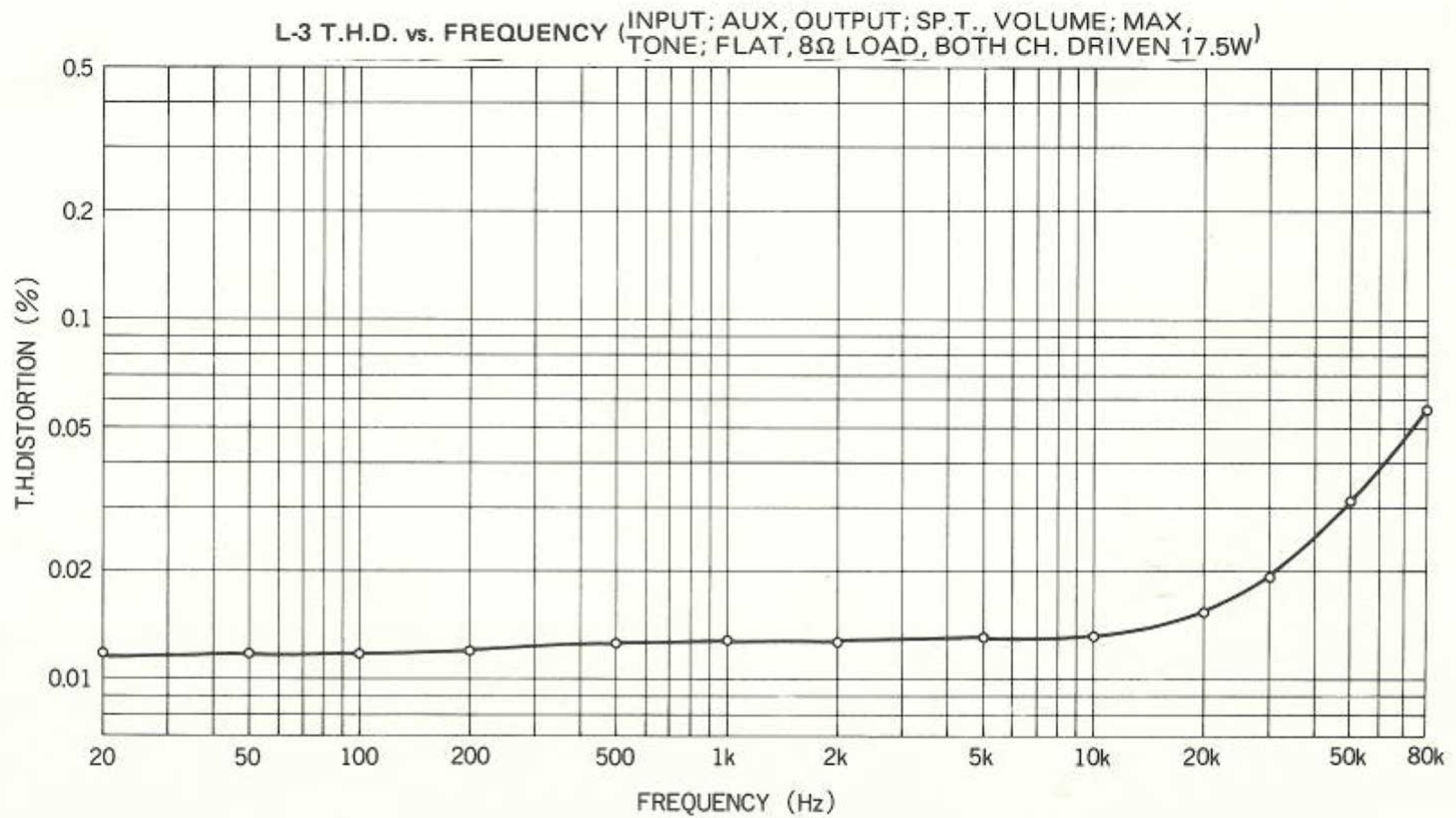
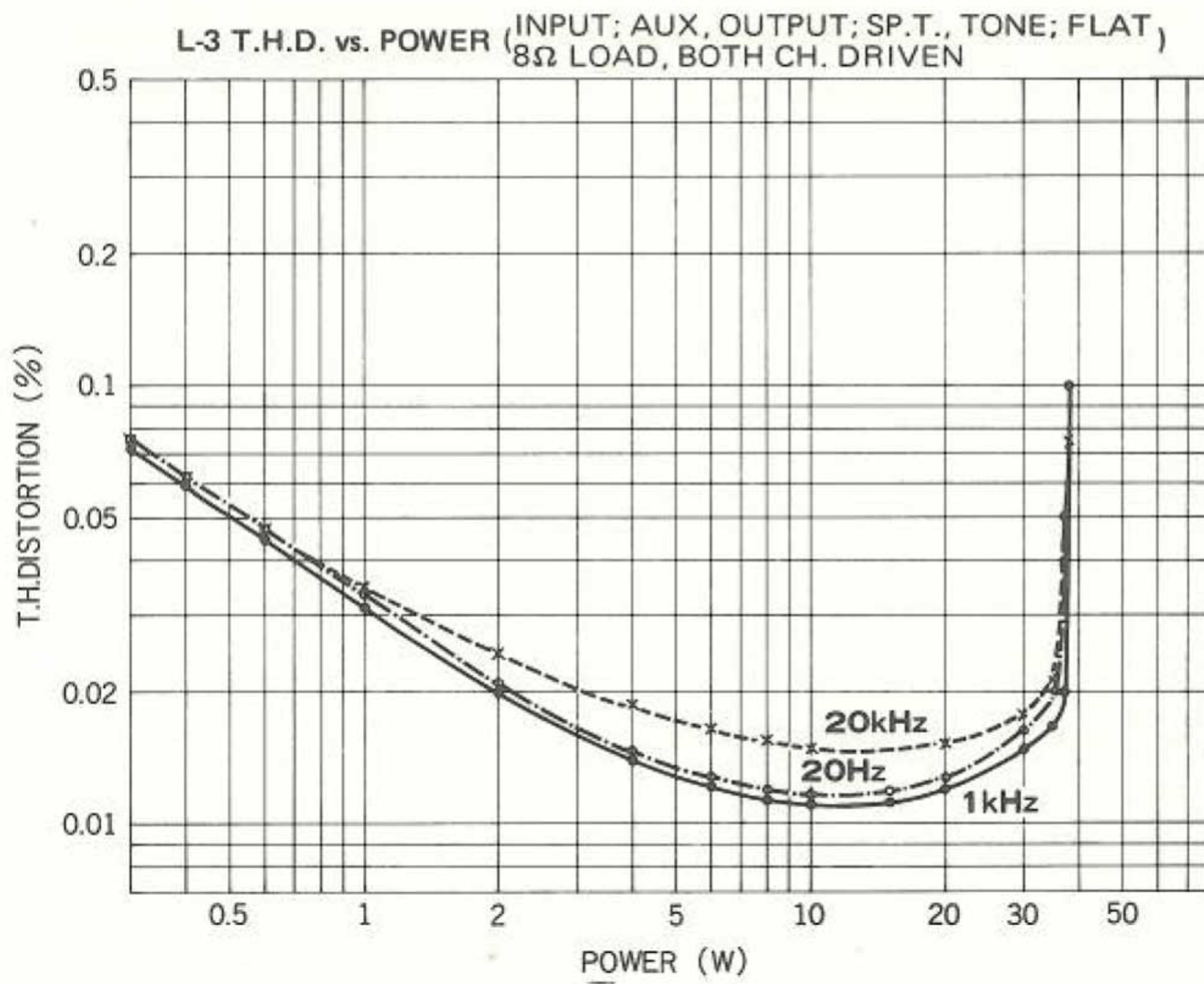
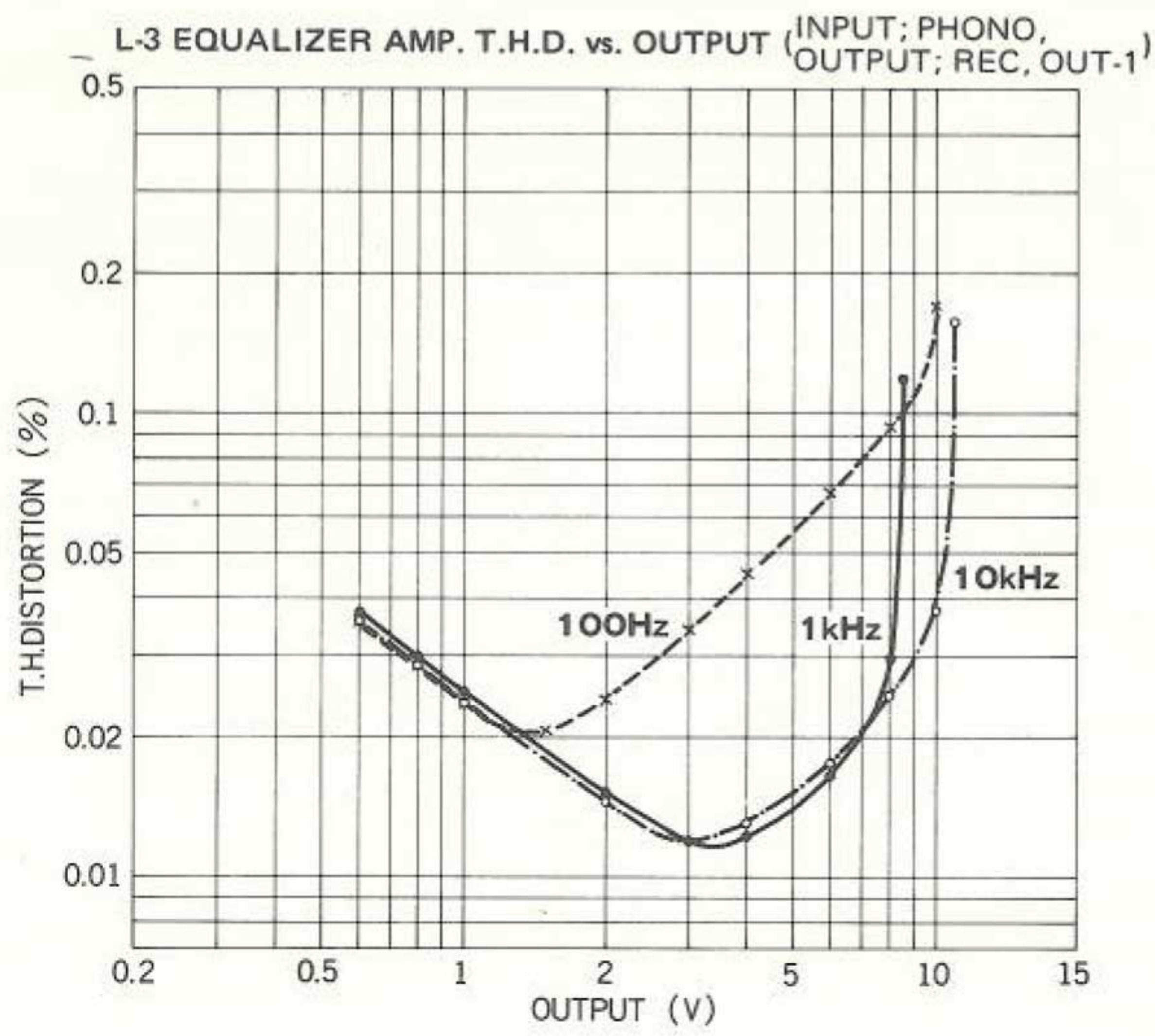

# SPECIFICATIONS

- RMS Power Output: 42W/42W (8 ohms, both ch. driven)
- Total Harmonic Distortion: no more than 0.03%  
(8 ohms, 42W/ch, both ch. driven)
- Rated I.M.: no more than 0.05%  
(8 ohms, 42W/ch, 60Hz: 7kHz = 4 : 1)
- Frequency Response: 15Hz ~ 60kHz (within -1dB)
- Input Sensitivity & Input Impedance:

PHONO	2.5mV	50k ohms
TUNER	145mV	50k ohms
AUX	145mV	50k ohms
MONITOR-1	145mV	50k ohms
MONITOR-2	145mV	50k ohms
- Signal-to-Noise Ratio: (input short-circuited)

PHONO	better than 84dB (IHF-A weighted, 10mV)
TUNER	better than 90dB (IHF-A weighted)
AUX	better than 90dB (IHF-A weighted)
MONITOR-1	better than 90dB (IHF-A weighted)
MONITOR-2	better than 90dB (IHF-A weighted)
- Residual Noise: no more than 1mV
- Tone Control: LUX NF type (100Hz ±11dB, 10kHz ±10dB)
- Filter:

High Cut	7kHz (-6dB/oct.)
Subsonic	25Hz (-6dB/oct.)
- Channel Separation:

PHONO	better than 60dB
AUX	better than 70dB
- Additional Features: Tape Monitor (dual), Tape Dubbing (dual), Loudness Control, Mode Selector, Speaker Selector (A, B, A+B, OFF) DIN Connector
- Dimensions: 438(W) x 289(D) x 105(H)  
(17-1/4" x 11-3/8" x 4-1/8")  
(including Legs, Rear Protrusions and Knobs)
- Weight:

Net	8.0kgs (17.6 lbs.)
Gross	9.5kgs (20.9 lbs.)

Specifications and appearance design are subject to possible change without notice.

**LUX CORPORATION, JAPAN**

1-1, 1-CHOME, SHINSENRI-NISHIMACHI, TOYONAKASHI,  
OSAKA, JAPAN PHONE: 06-834-2222 TELEX: J63694

**LUX AUDIO OF AMERICA, LTD.**

160 DUPONT ST. PLAINVIEW, NEW YORK 11803 U.S.A.